

FEATURES

- Adjustable from 1.23V to 42V
- High Accuracy Output Voltage
- Extremely Low Quiescent Current
- Low Dropout Voltage
- Tight Load and Line Regulation
- Low Temperature Coefficient
- Current and Thermal Protection
- Unregulated DC Positive Transients 60V
- Error Flag Warning of Voltage Output Dropout
- Logic Controlled Electronic Shutdown

APPLICATIONS

- Telephone Systems
- High Voltage Power Supply
- Cordless Telephones
- Laboratory Instrumentation
- Radio Control Systems
- Automotive Electronics
- Avionics

GENERAL DESCRIPTION

The AMS2942 are micropower voltage regulators ideally suited for use with high voltage powered systems. This device feature very low quiescent current (typ.130 μ A), and very low dropout voltage (typ.45mV at light loads and 380mV at 100mA). The quiescent current increases only slightly in dropout. The AMS2942 has positive transient protection up to 60V and can survive unregulated input transient up to 20V below ground.

AMS2942 is designed with a tight initial voltage reference tolerance, excellent load and line regulation (typ. 0.05%), and a very low output voltage temperature coefficient, making these devices useful as a low-power voltage regulator in telephone applications, using the telephone line as a power source.

The AMS2942 is available in a special 8-pin plastic SOIC in which pin 2 and 3 are fused together with the package paddle serving also as heat sink. An error flag output warns of a low output voltage, often due to failing voltage on input line. A logic-compatible shutdown input is available, which enables the regulator to be switched on and off. The output voltage can be programmed from 1.23V to 42V with an external pair of resistors.

ORDERING INFORMATION

PACKAGE TYPE	OPERATING TEMP. RANGE
8 LEAD SOIC	
AMS2942AS	IND
AMS2942BS	IND

PIN CONNECTION

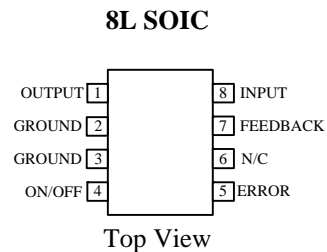

ABSOLUTE MAXIMUM RATINGS (Note 1)

Input Supply Voltage	-0.3 to +50V
Power Dissipation	Internally Limited
Junction Temperature	+150°C
Storage Temperature	-65°C to +150°C
Soldering (25 Sec.)	265°C

ESD 2000V

OPERATING RATINGS (Note 1)

Max. Input Supply Voltage	45V
Junction Temperature Range (T _J) (Note 8)	-40°C to +125°C

ELECTRICAL CHARACTERISTICS at V_S=V_{OUT}+1V, T_A=25°C, unless otherwise specified.

Parameter	Conditions (Note 2)	AMS2942A			AMS2942B			Units
		Min.	Typ.	Max.	Min.	Typ.	Max.	
Reference Voltage		1.22	1.235	1.25	1.21	1.235	1.26	V
Reference Voltage	Over Temperature (Note 7)	1.19		1.27	1.185		1.285	V
Output Voltage Temperature Coefficient	(Note 10) (Note 4)		20			50		ppm/°C
Line Regulation (Note 12)	6V ≤ V _{IN} ≤ 45V (Note 13)		0.05	0.2		0.1	0.4	%
Load Regulation (Note 12)	100 μA ≤ I _L ≤ 100 mA		0.05	0.2		0.1	0.4	%
Dropout Voltage (Note 5)	I _L = 100 μA I _L = 100 mA		50	80		50	80	mV
			380	450		380	450	mV
Ground Current	I _L = 100 μA I _L = 100 mA		120	180		120	180	μA
			8	12		8	12	mA
Current Limit	V _{OUT} = 0		160	200		160	200	mA
Thermal Regulation	(Note 11)		0.05	0.2		0.05	0.2	%/W
Output Noise, 10Hz to 100KHz	C _L = 1 μF C _L = 200 μF C _L = 13.3 μF (Bypass = 0.01 μF pins 7 to 1)		430			430		μV rms
			160			160		μV rms
			100			100		μV rms
Feedback Pin Bias Current			40	80		40	80	nA
Reference Voltage Temperature Coefficient	(Note 10)		20			50		ppm/°C
Feedback Pin Bias Current Temperature Coefficient			0.1				0.1	nA/°C
Error Comparator								
Output Leakage Current	V _{OH} = 42V		0.05	2		0.05	2	μA
Output Low Voltage	V _{IN} = 4.5V, I _{OL} = 400μA		150	250		150	250	mV
Upper Threshold Voltage	(Note 6)	40	60		40	60		mV
Lower Threshold Voltage	(Note 6)		75	95		75	95	mV
Hysteresis	(Note 6)		15			15		mV
Shutdown Input								
Input logic Voltage	Low (Regulator ON)		1.3	0.7		1.3	0.7	V
	High (Regulator OFF)	2.5			2.5			V
Shutdown Pin Input Current (Note 3)	V _S = 2.5V		30	60		30	60	μA
	V _S = 42V		600	850		600	850	μA
Regulator Output Current in Shutdown (Note 3)	(Note 9)		15	50		15	50	μA

BLOCK DIAGRAM AND TYPICAL APPLICATIONS

AMS2942

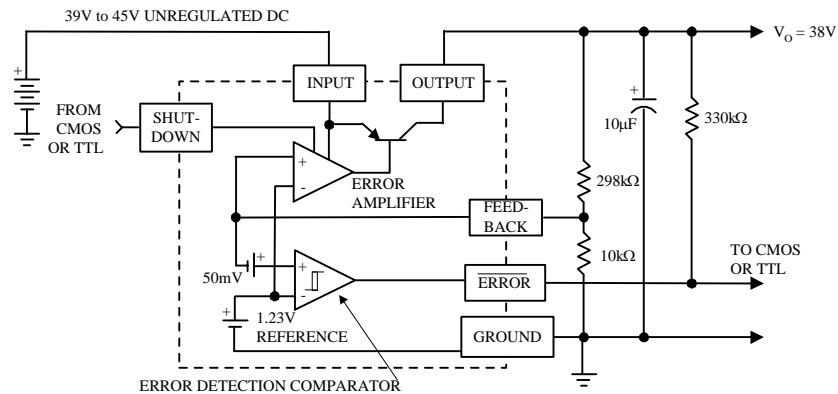

Note 1: Absolute Maximum Ratings are limits beyond which damage to the device may occur. Operating Ratings are conditions under which operation of the device is guaranteed. Operating Ratings do not imply guaranteed performance limits. For guaranteed performance limits and associated test conditions, see the Electrical Characteristics tables.

Note 2: Unless otherwise specified all limits guaranteed for $V_{IN} = (V_{ONOM} + 1)V$, $I_L = 100 \mu A$ and $C_L = 1 \mu F$. Limits appearing in **boldface** type apply over the entire junction temperature range for operation. Limits appearing in normal type apply for $T_A = T_J = 25^\circ C$, $V_{SHUTDOWN} \leq 0.8V$.

Note 3: Guaranteed and 100% production tested.

Note 4: Guaranteed but not 100% production tested. These limits are not used to calculate outgoing AQL levels.

Note 5: Dropout voltage is defined as the input to output differential at which the output voltage drops 100 mV below its nominal value measured at 1V differential. At very low values of programmed output voltage, the minimum input supply voltage of 2V (2.3V over temperature) must be taken into account.

Note 6: Comparator thresholds are expressed in terms of a voltage differential at the feedback terminal below the nominal reference voltage measured at $V_{IN} = (V_{ONOM} + 1)V$. To express these thresholds in terms of output voltage change, multiply by the error amplifier gain = $V_{out}/V_{ref} = (R1 + R2)/R2$. For example, at a programmed output voltage of 5V, the error output is guaranteed to go low when the output drops by $95 mV \times 5V/1.235 = 384 mV$. Thresholds remain constant as a percent of V_{out} as V_{out} is varied, with the dropout warning occurring at typically 5% below nominal, 7.5% guaranteed.

Note 7: $V_{ref} \leq V_{out} \leq (V_{in} - 1V)$, $2.3 \leq V_{in} \leq 42V$, $100\mu A \leq I_L \leq 100 mA$, $T_J \leq T_{JMAX}$.

Note 8: The junction-to-ambient thermal resistance is $120^\circ C/W$ for the molded plastic SO-8 (S), when the package is soldered directly to the PCB.

Note 9: $V_{SHUTDOWN} \geq 2.5V$, $V_{IN} \leq 42V$, $V_{OUT} = 0$.

Note 10: Output or reference voltage temperature coefficients defined as the worst case voltage change divided by the total temperature range.

Note 11: Thermal regulation is defined as the change in output voltage at a time T after a change in power dissipation is applied, excluding load or line regulation effects. Specifications are for a 50mA load pulse at $V_{IN} = 42V$ (1.25W pulse) for $T = 10 ms$.

Note 12: Regulation is measured at constant junction temperature, using pulse testing with a low duty cycle. Changes in output voltage due to heating effects are covered under the specification for thermal regulation.

Note 13: Line regulation is tested at $150^\circ C$ for $I_L = 1 mA$. For $I_L = 100 \mu A$ and $T_J = 125^\circ C$, line regulation is guaranteed by design to 0.2%. See typical performance characteristics for line regulation versus temperature and load current.

TYPICAL PERFORMANCE CHARACTERISTICS

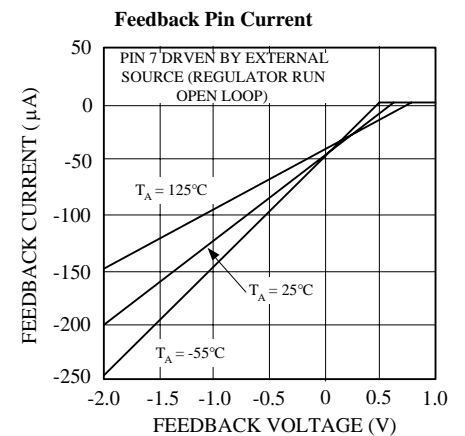
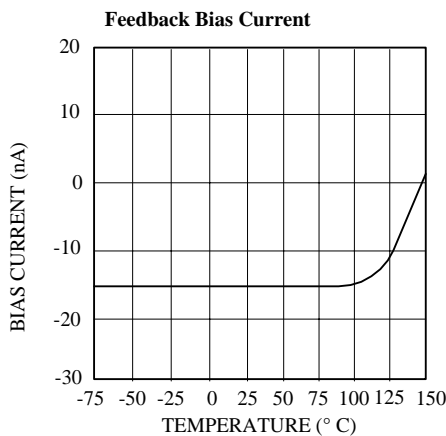
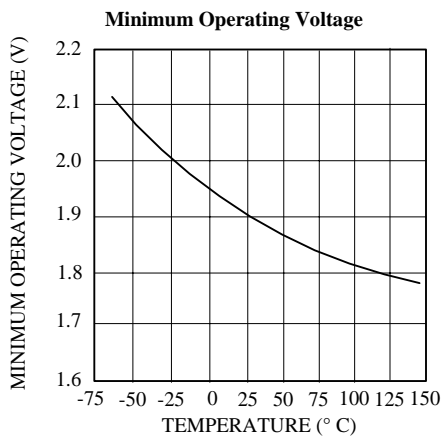
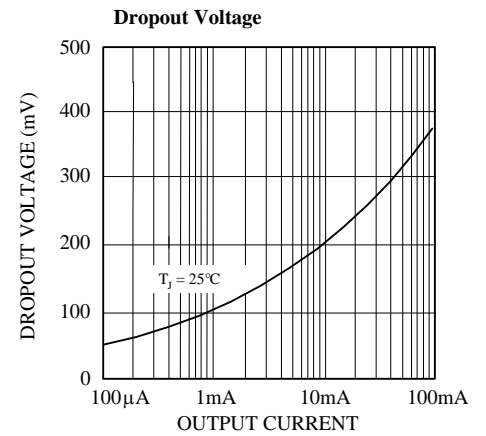
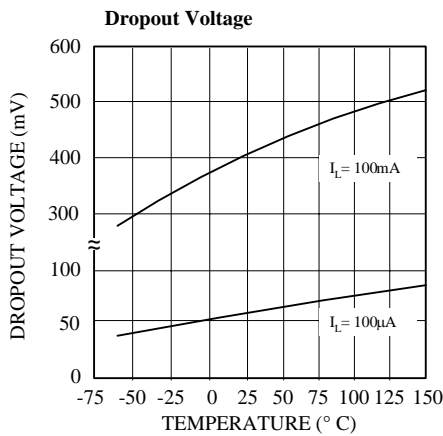
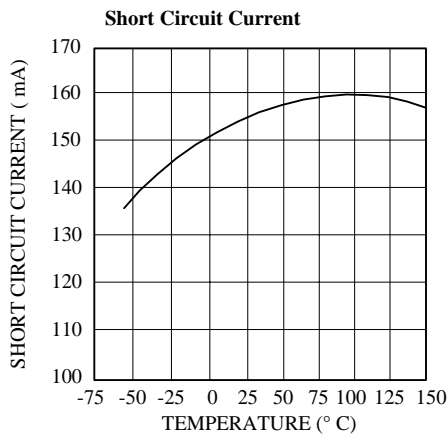
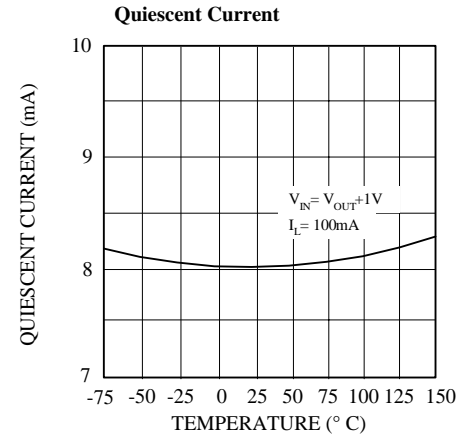
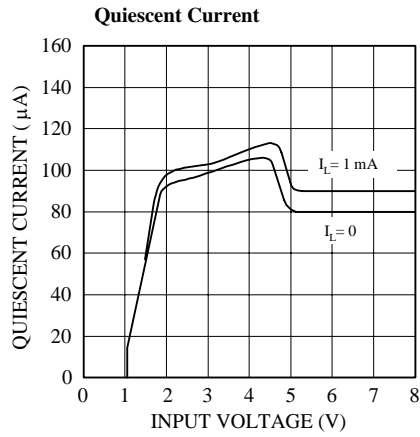
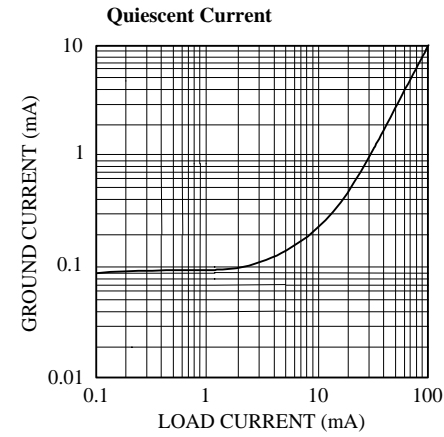

TYPICAL PERFORMANCE CHARACTERISTICS (Continued)

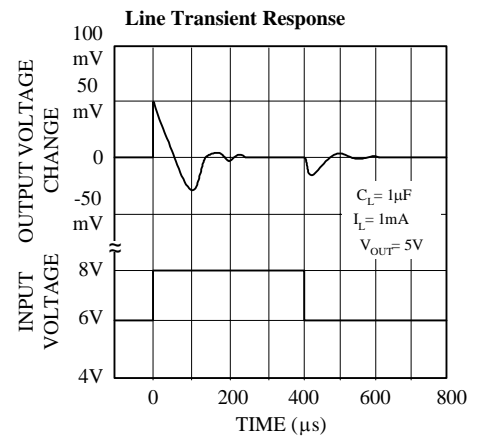
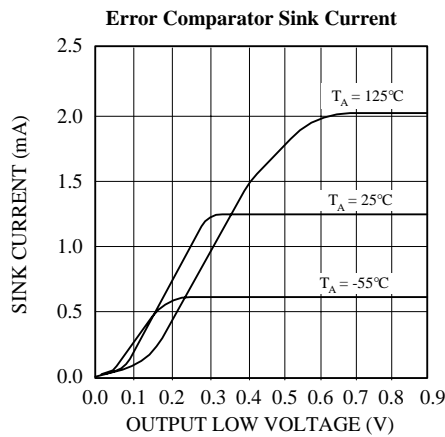
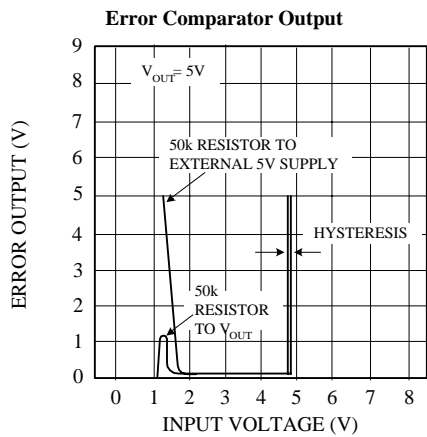
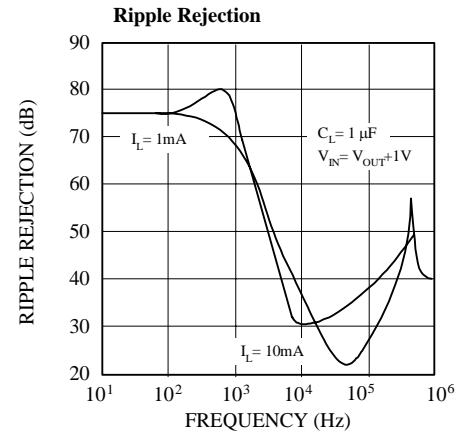
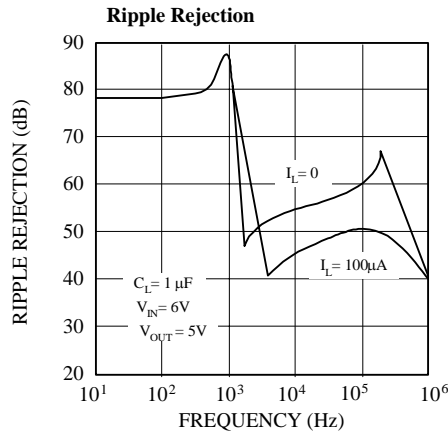
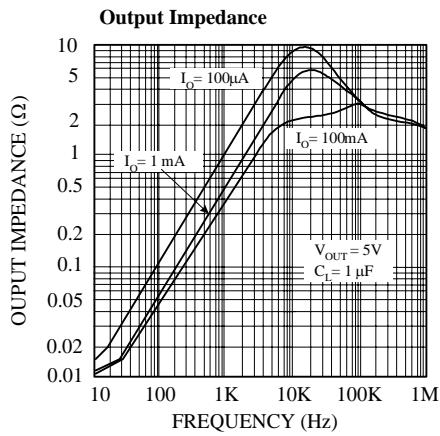
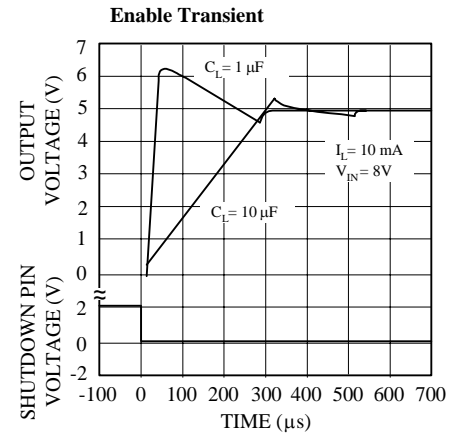
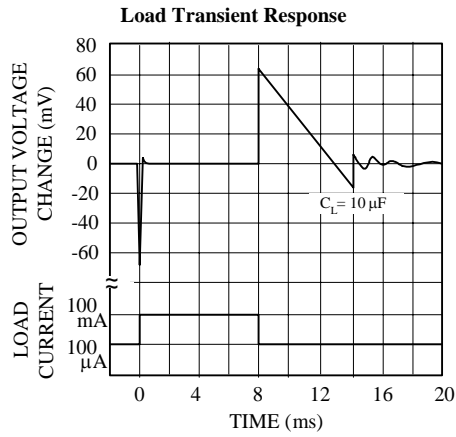
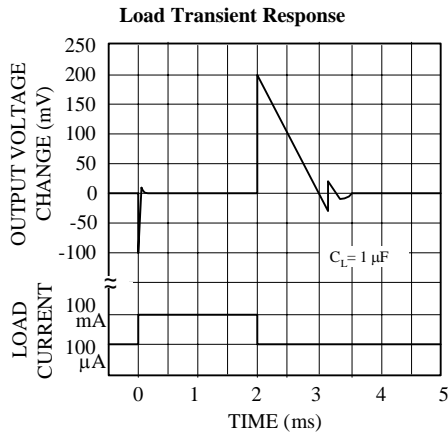

APPLICATION HINTS

External Capacitors

A 1.0 μF or greater capacitor is required between output and ground for stability at output voltages of 5V or more. At lower output voltages, more capacitance is required. Without this capacitor the part will oscillate. Most types of tantalum or aluminum electrolytic works fine here; even film types work but are not recommended for reasons of cost. Many aluminum types have electrolytes that freeze at about -30°C , so solid tantalums are recommended for operation below -25°C . The important parameters of the capacitor are an ESR of about $5\ \Omega$ or less and resonant frequency above 500 kHz parameters in the value of the capacitor. The value of this capacitor may be increased without limit.

At lower values of output current, less output capacitance is required for stability. The capacitor can be reduced to $0.33\ \mu\text{F}$ for currents below 10 mA or $0.1\ \mu\text{F}$ for currents below 1 mA. At voltages below 5V the error amplifier operates at lower gains so that more output capacitance is needed. For the worst-case situation of a 100mA load at 1.23V output (Output shorted to Feedback) a $3.3\ \mu\text{F}$ (or greater) capacitor should be used.

A $1\ \mu\text{F}$ tantalum or aluminum electrolytic capacitor should be placed between input to ground if there is more than 10 inches of wire between the input and the AC filter capacitor or if a battery is used as the input.

Stray capacitance to Feedback terminal can cause instability. This may especially be a problem when using a higher value of external resistors to set the output voltage. Adding a 100 pF capacitor between Output and Feedback and increasing the output capacitor to at least $3.3\ \mu\text{F}$ will fix this problem.

Error Detection Comparator Output

The comparator produces a logic low output whenever the output falls out of regulation by more than approximately 5%. This figure is the comparator's built-in offset of about 60 mV divided by the 1.235 reference voltage. This trip level remains "5% below normal" regardless of the programmed output voltage. For example, the error flag trip level is typically 4.75V for a 5V output or 11.4V for a 12V output. The out of regulation condition may be due either to low input voltage, current limiting, or thermal limiting.

Figure 1 gives a timing diagram depicting the ERROR signal and the regulator output voltage as the AMS2942 input is ramped up and down.

Since the dropout voltage is load dependent the input voltage trip point will vary with the load current. The output voltage trip point does not vary with load. The error comparator has an open-collector output which requires an external pullup resistor. This resistor may be returned to the output or some other supply voltage depending on system requirements. In determining a value for this resistor, note that the output is rated to sink $400\ \mu\text{A}$. Suggested values range from 100K to $1\ \text{M}\Omega$. The resistor is not required if error flag terminal is unused.

Setting the Output Voltage

The AMS2942 it may be programmed for any output voltage between its 1.235V reference and its 42V maximum rating. As seen in Figure 2, an external pair of resistors is required.

The complete equation for the output voltage is:

$$V_{\text{out}} = V_{\text{REF}} \times (1 + R_1/R_2) + I_{\text{FB}}R_1$$

where V_{REF} is the nominal 1.235 reference voltage and I_{FB} is the feedback pin bias current, nominally $-20\ \text{nA}$. The minimum recommended load current of $1\ \mu\text{A}$ forces an upper limit of $1.2\ \text{M}\Omega$ on value of R_2 , if the regulator must work with no load (a condition often found in CMOS in standby) I_{FB} will produce a 2% typical error in V_{OUT} which may be eliminated at room temperature by trimming R_1 . For better accuracy, choosing $R_2 = 100\text{k}$ reduces this error to 0.17%.

Reducing Output Noise

In reference applications it may be an advantageous to reduce the AC noise present at the output. One method is to reduce the regulator bandwidth by increasing the size of the output capacitor. Noise could be reduced fourfold by a bypass capacitor across R_1 , since it reduces the high frequency gain from 4 to unity. Pick

$$C_{\text{BYPASS}} \cong 1 / 2\pi R_1 \times 200\ \text{Hz}$$

or about $0.01\ \mu\text{F}$. When doing this, the output capacitor must be increased to $3.3\ \mu\text{F}$ to maintain stability. These changes reduce the output noise from $430\ \mu\text{V}$ to $100\ \mu\text{V}$ rms for a 100 kHz bandwidth at 5V output. With the bypass capacitor added, noise no longer scales with output voltage so that improvements are more dramatic at higher output voltages.

APPLICATION HINTS (Continued)

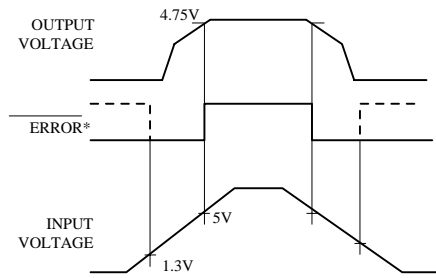

FIGURE 1. ERROR Output Timing

*When $V_{IN} \leq 1.3V$ the error flag pin becomes a high impedance, and the error flag voltage rises to its pull-up voltage. Using V_{out} as the pull-up voltage (see Figure 2), rather than an external 5V source, will keep the error flag voltage under 1.2V (typ.) in this condition. The user may wish to drive down the error flag voltage using equal value resistors (10 k Ω suggested), to ensure a low-level logic signal during any fault condition, while still allowing a valid high logic level during normal operation.

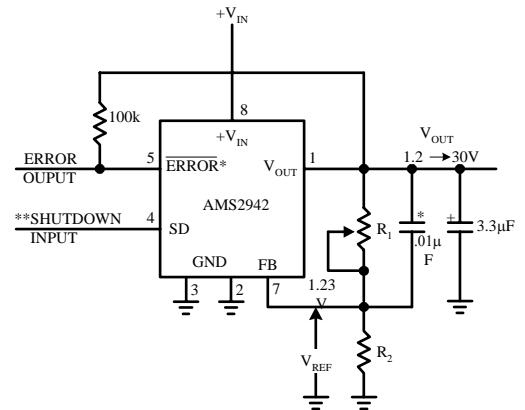

FIGURE 2. Adjustable Regulator

*See Application Hints.

$$V_{out} = V_{REF} \times (1 + R_1/R_2)$$

**Drive with TTL- high to shut down. Ground or leave if shutdown feature is not used.

Note: Pins 2 and 6 are left open.

PACKAGE DIMENSIONS inches (millimeters) unless otherwise noted.

8 LEAD SOIC PLASTIC PACKAGE (S)

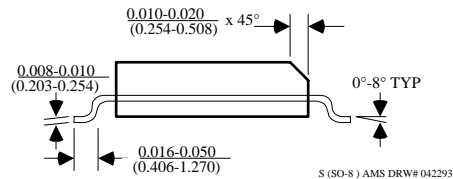
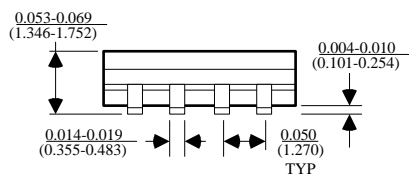
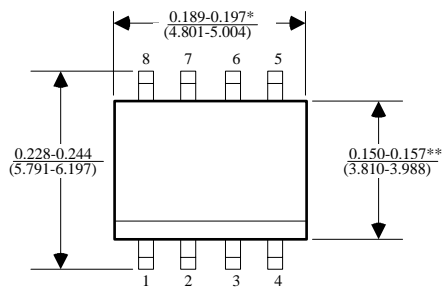

*DIMENSION DOES NOT INCLUDE MOLD FLASH. MOLD FLASH SHALL NOT EXCEED 0.006" (0.152mm) PER SIDE

**DIMENSION DOES NOT INCLUDE INTERLEAD FLASH. INTERLEAD FLASH SHALL NOT EXCEED 0.010" (0.254mm) PER SIDE